

OMRON

Solid-State Timer

H3G

Low-Cost, Plug-In Timer with Large Switching Capacity

- Up to 7-amp switching capacity
- Choose SPDT or DPDT contact form
- 12 time ranges
- Fits standard 8-pin sockets
- Ideal replacement for time relays
- Subminiature DIN size, 36 x 36 mm
- LED power-ON indicator
- Timer hold-down clips supplied
- Panel mounting adapter, sockets, and accessories may be ordered separately



Ordering Information

■ TIMERS

Add the supply voltage and time range code to the part number when you order. For example, **H3G-8A AC100/110/120-60s**.

Timing function		ON-delay	
Contact type	Time limit	SPDT	DPDT
	Instantaneous	–	–
Terminal form		8-pin round socket	
Part number		H3G-8A	H3G-8C
Supply voltages	AC	24 V, 100/110/120 V or 200/220/240 V; 50/60 Hz	
	DC	12 V or 24 V	
Time range codes		1 s, 3 s, 5 s, 10 s, 30 s, 60 s, 3 m, 5 m, 10 m, 30 m, 60 m, or 3 h	

■ TIME RANGES

Code	Range	Code	Range	Code	Range
1s	0.1 to 1 second	30 s	3 to 30 seconds	10m	1 to 10 minutes
3 s	0.3 to 3 seconds	60 s	6 to 60 seconds	30 m	3 to 30 minutes
5 s	0.5 to 5 seconds	3 m	0.3 to 3 minutes	60 m	6 to 60 minutes
10 s	1 to 10 seconds	5 m	0.5 to 5 minutes	3 h	0.3 to 3 hours

■ ACCESSORIES

Description	Part number
Sockets	Bottom surface or track mounting, top screw terminals, molded standoff ring
	Bottom surface or track mounting, top screw terminals
	Back mounting, for use with Y92F-31 mounting adapter, bottom screw terminals
Panel mounting adapter	Fits behind panel. Use P3G-08 socket.
Mounting track	DIN rail, 50 cm (1.64 ft) length
	DIN rail, 1 m (3.28 ft) length
	End plate
	Spacer

■ REPLACEMENT PARTS

Description	Part number
Timer hold-down clips, one pair	Y92H-6

Specifications

Part number		H3G-8A	H3G-8C
Supply voltage	AC	24 V, 100/110/120 V or 200/220/240 V; 50/60 Hz	
	DC	12 V or 24 V	
Operating voltage		85 to 110% of rated voltage	
Power consumption	AC	3.4 VA at 200 VAC	
	DC	-	
Timing functions		ON-delay	
Control inputs		-	-
Control output	Type	SPDT	DPDT
	Time limit	-	-
	Instantaneous	-	-
	Max. load	7 A, 125/250 VAC (resistive load)	5 A, 125/250 VAC (resistive load)
Min. load	100 mA, 5 VDC	100 mA, 5 VDC	
Repeat accuracy		± 2% max.	
Setting error		± 10% max.	
Resetting system		Power-off	
Resetting time		100 ms	
Indicators		Power ON (red LED)	
Materials		Plastic case, knob	
Mounting		Panel, track or surface	
Connections		8-pin round socket	
Weight		55 g (2.0 oz.)	
Approvals		UL/CSA	
Operating ambient temperature		-10° to 55°C (14° to 131°F)	
Humidity		35 to 85% RH	
Vibration	Mechanical durability	10 to 55 Hz; 0.75 mm (0.03 in) double amplitude	
	Malfunction durability	10 to 55 Hz; 0.5 mm (0.02 in) double amplitude	
Shock	Mechanical durability	100 G	
	Malfunction durability	10 G	
Variation due to voltage change		± 2% max.	
Variation due to temperature change		± 5% max.	
Insulation resistance		100 MΩ min. at 500 VDC	
Dielectric strength		2,000 VAC, 50/60 Hz for 1 minute between current-carrying and non-current-carrying parts, and between contact carrying and control circuit and between contacts of different poles. 1,000 VAC, 50/60 Hz for 1 minute between non-continuous contacts	
Service life	Mechanical	10 million operations min.	
	Electrical	100,000 operations min. at maximum ratings	

Engineering Data

■ ELECTRICAL SERVICE LIFE

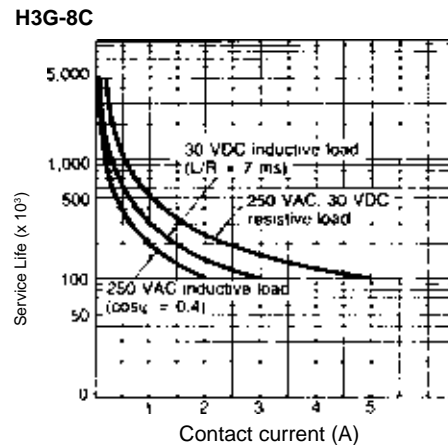
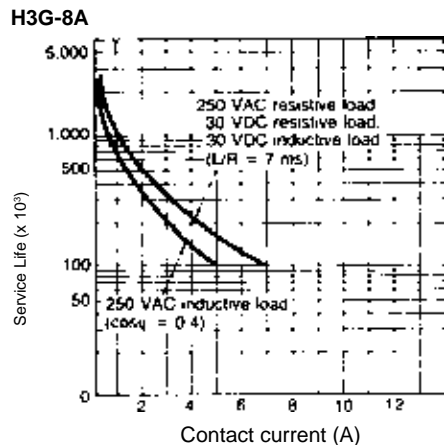

Timing Charts

In the schematic diagrams, each **thick line** indicates the external wiring.

H3G-8A

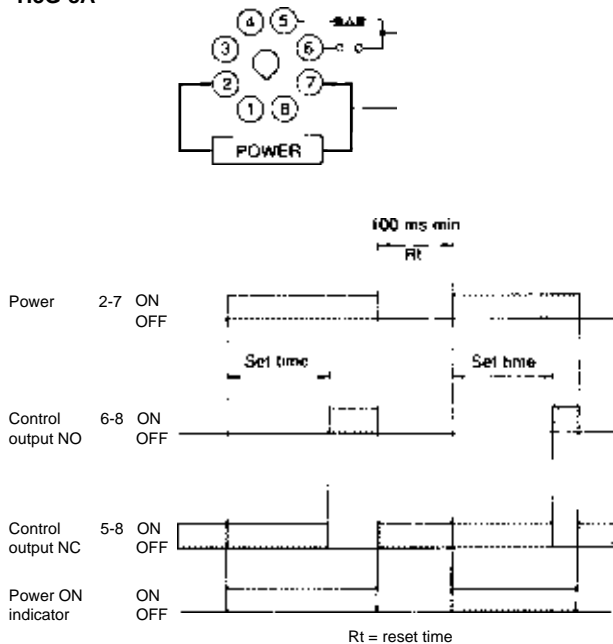

H3G-8C

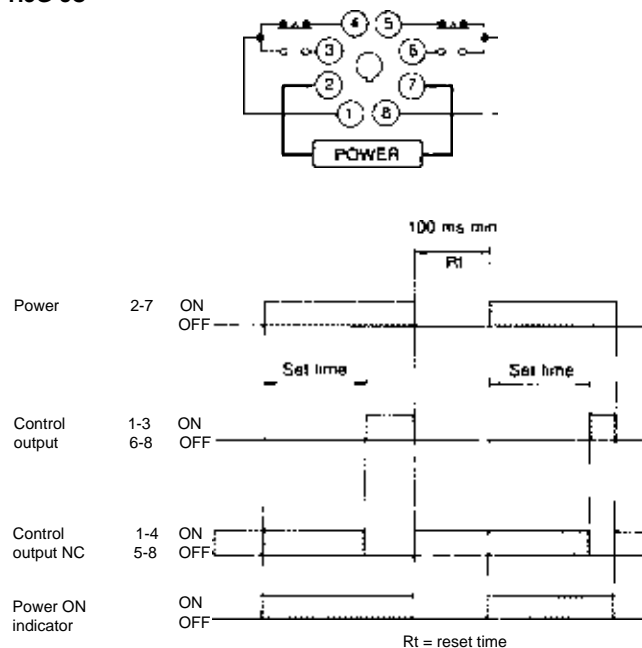

Dimensions

Unit: mm (inch)

TIMERS

H3G-8A, H3G-8C

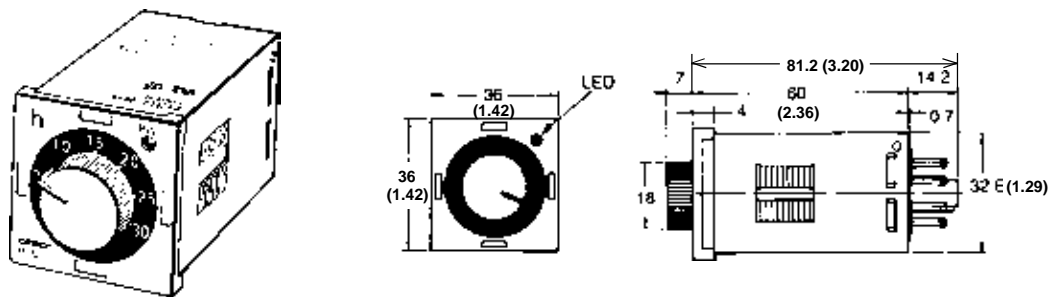

SOCKETS

PF083A-E Bottom Surface or Track Mounting Socket with Molded Standoff Ring

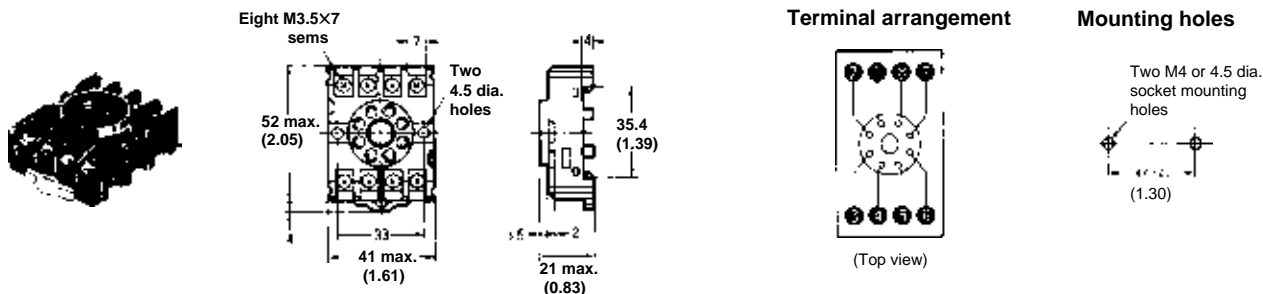

PF085A Bottom Surface on Track Mounting Socket

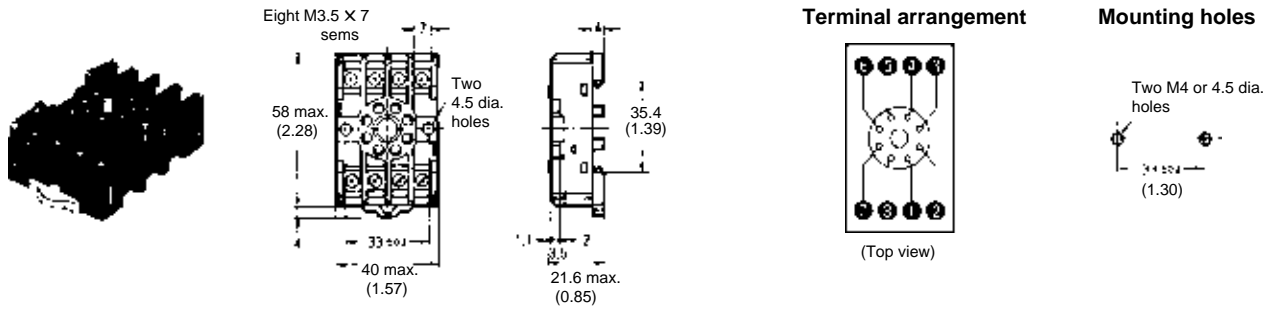

P3G-08 Back Mounting Socket

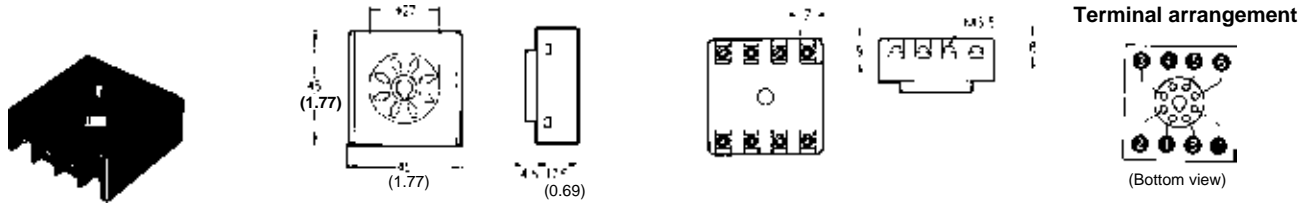

■ PANEL MOUNTING ADAPTER

Y92F-31 Mounting Adapter

Adapter installs behind the panel. It is ideal for side by side installation. Use P3G-08 socket.

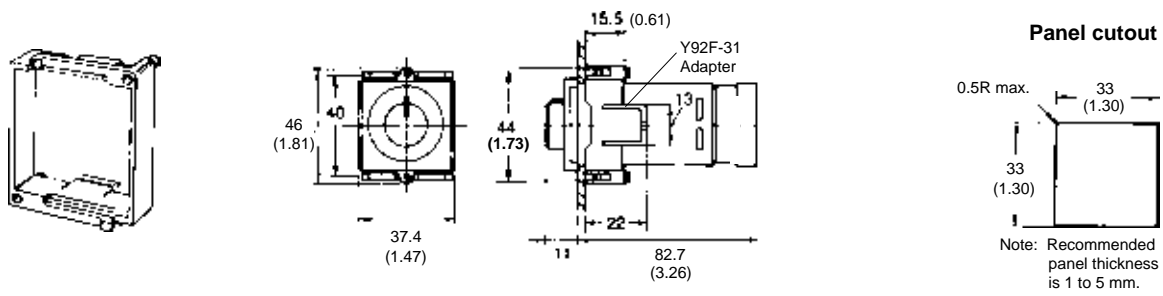

■ MOUNTING TRACK AND ACCESSORIES

PFP-100N/PFP-50N DIN Rail Track

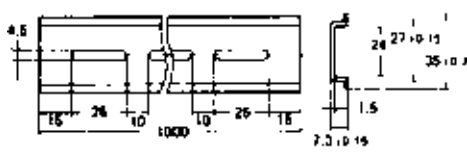

PFP-M End Plate

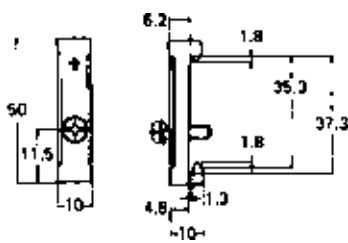

PFP-S Spacer

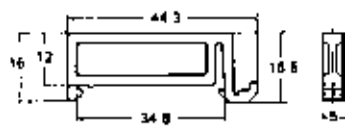

■ REPLACEMENT PARTS

Y92H-6 Hold-Down Clips

One pair of clips are packed with the H3G timer.

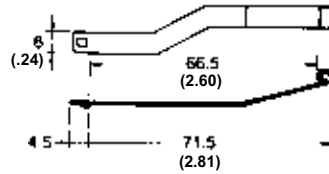

Connections

Part number	Power supply terminal numbers		Output terminal numbers		
	AC (common), DC-	AC (hot), DC+	COM	NC	NO
H3G-8A	2	7	8	5	6
H3G-8C	2	7	1	4	3

Mounting

■ PANEL MOUNTING

Insert the timer through the panel cutout. Push the Y92F-31 adapter from the rear of the timer as far forward toward the panel as possible.

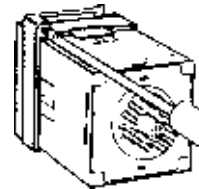

Using Y92F-31 Adapter

Push the P3G-08 onto the rear of the timer, then wire the socket. Tighten the two retaining screws on the adapter. To release the adapter, lift the tab at the rear of the adapter.

■ TRACK MOUNTING

PF083A-E and PF085A

Mounting

Insert the timer into the socket then clip the rear of the socket onto the track. Push the bottom onto the track until the latch fastens securely.

Removal

Pull the latch on the socket with a flat-blade screwdriver and remove the timer and socket as one unit.

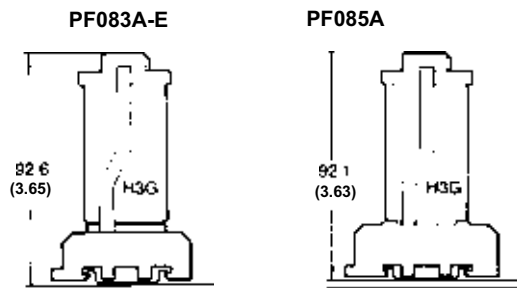

NOTE: ALL DIMENSIONS ARE IN MILLIMETERS. To convert millimeters into inches divide by 25.4.



OMRON ELECTRONICS, INC.
 One East Commerce Drive
 Schaumburg, IL 60173
1-800-55-OMRON

OMRON CANADA, INC.
 885 Milner Avenue
 Scarborough, Ontario M1B 5V8
416-286-6465

Cat. No. GC T18

11/97

Specifications subject to change without notice.

Printed in the U.S.A.



ASH & ALAIN

3gfZad[eW 6[efdTgfad;Ž

ASH & ALAIN INDIA PVT LTD

S-100, F.I.E.E., Okhla Industrial Area, Phase-ii, New Delhi-110020(India)

Tel : 011-43797575 Fax : 011-43797574 E-mail : sales@ashalain.com